



PRX318SD

18 Inch Compact Subwoofer System

Professional Series

Key Features:

- ▶ JBL 2043-G 18-inch woofer with 3-inch voice coil for extended and powerful bass reproduction
- ▶ 350 watt (continuous), 1400 watt (peak) power capacity
- ▶ Rugged enclosure made from 18mm MDF (Medium Density Fiberboard)
- ▶ Top-mounted cast aluminum 36-mm pole mount receptacle facilitates use with a full-range speaker
- ▶ All-steel handles are integrated to the sides for transport and setup convenience
- ▶ Dent-resistant grille protects the internal from damage on the move or during the show

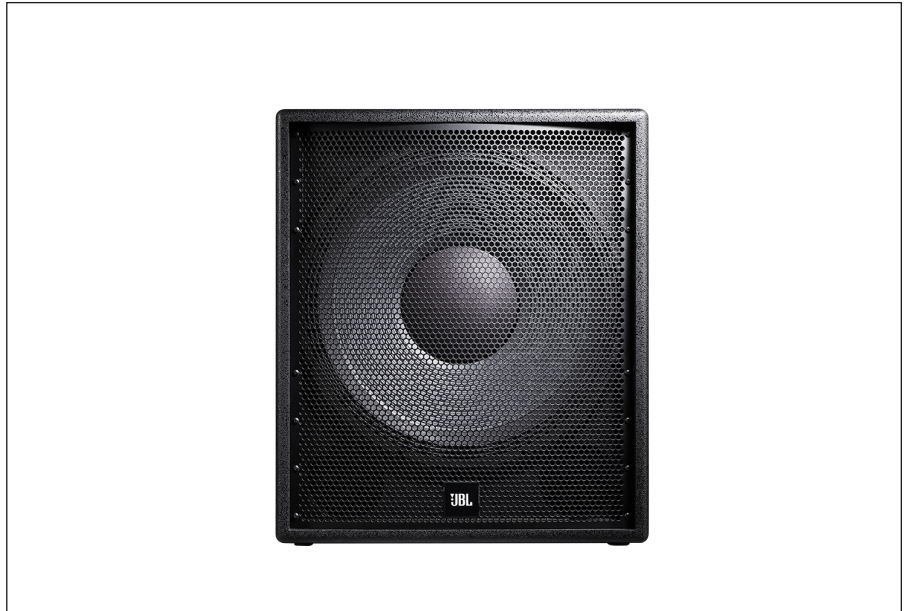

Applications:

- ▶ For extra bass effect in live performance or music playback

PRX318SD is a compact direct-radiation 18-inch subwoofer system designed for bass effect in live performance or music playback applications.

PRX318SD installs the JBL 2043-G 18-inch woofer with 3-inch voice coil in a direct radiation format to reproduce loud and powerful low frequencies. According to JBL Professional's toughest 100-hour extended life test, the sub system is capable of handling 350 watt continuous power and 1400 watt peak. A 36-mm pole mount receptacle on the top receives the SS3BK pole to facilitate use with a full range speaker. Two all-steel handles are integrated to the sides for transport and setup convenience. For extreme durability and optimum low frequency response, PRX318SD constructs its enclosure from 18mm MDF (Medium Density Fiberboard) using advanced adhesives and mechanical fastener technology. For the front of the system, a dent-resistant grille made from 18-gauge perforated steel protects the components inside from damage on the move or during the show.

Specifications:

System Type:	18" compact subwoofer
Frequency Range (-10 dB) ¹ :	38 Hz – 300 Hz
Frequency Response (± 3 dB) ¹ :	47 Hz – 300 Hz
Sensitivity (1w@1m):	96 dB SPL
Nominal Impedance:	4 Ω
Rated Maximum SPL ² :	133 dB peak, @1m (3.3 ft)
Power Capacity ³ :	350 watts
Peak Power Capacity ³ :	1400 watts
Recommended Amplifier Power:	350 - 700 watts @ 4 Ω
Dimensions (H x W x D):	593 mm x 503 mm x 551 mm (23.4 in x 19.8 in x 21.7 in)
Net Weight:	29.8 kg (65.7 lbs)
Shipping Weight:	36.5 kg (80.5 lbs)
LF Driver:	1 x 2043-G
Input Connector:	Neutrik Speakon® NL-4 (x2); 1/4" TS phone jack (x1) parallel
Enclosure Construction:	18 mm (0.7 in) MDF (Medium Density Fiberboard) with glued and mechanically fastened joint detail; black painting.
Grille:	18-gauge, powder-coated steel
Optional Accessory:	SS3-BK

1 Frequency Range and Frequency Response are based on half-space conditions.

2 Calculated half-space (2π) performance based upon peak power capacity.

3 Power Capacity and Peak Power Capacity ratings are based on the average and peak power capacity of product samples subject to a 100 hour power test using random noise with a 6 dB crest factor, in accordance with IEC standards.

JBL continually engages in research related to product improvement. Some materials, production methods and design refinements are introduced into existing products without notice as a routine expression of that philosophy. For this reason, any current JBL product may differ in some respect from its published description, but will always equal or exceed the original design specifications unless otherwise stated.

▶ PRX318SD 18 Inch Compact Subwoofer System

Frequency Response:

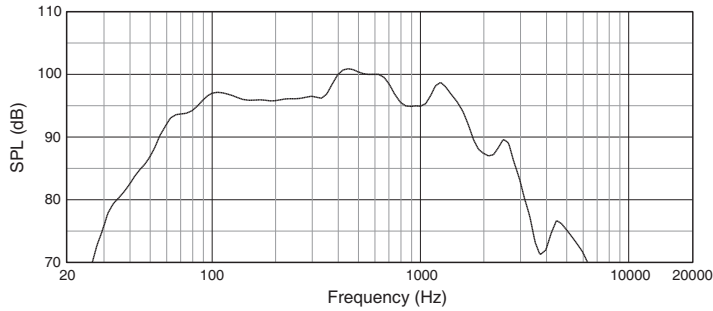

Block Diagram:

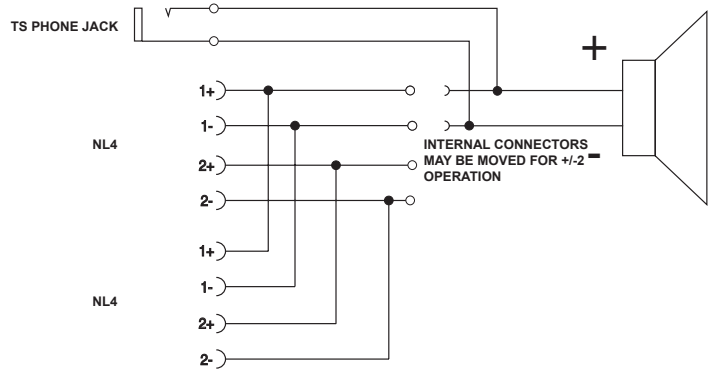

Dimensions:

Dimensions in mm (inch)

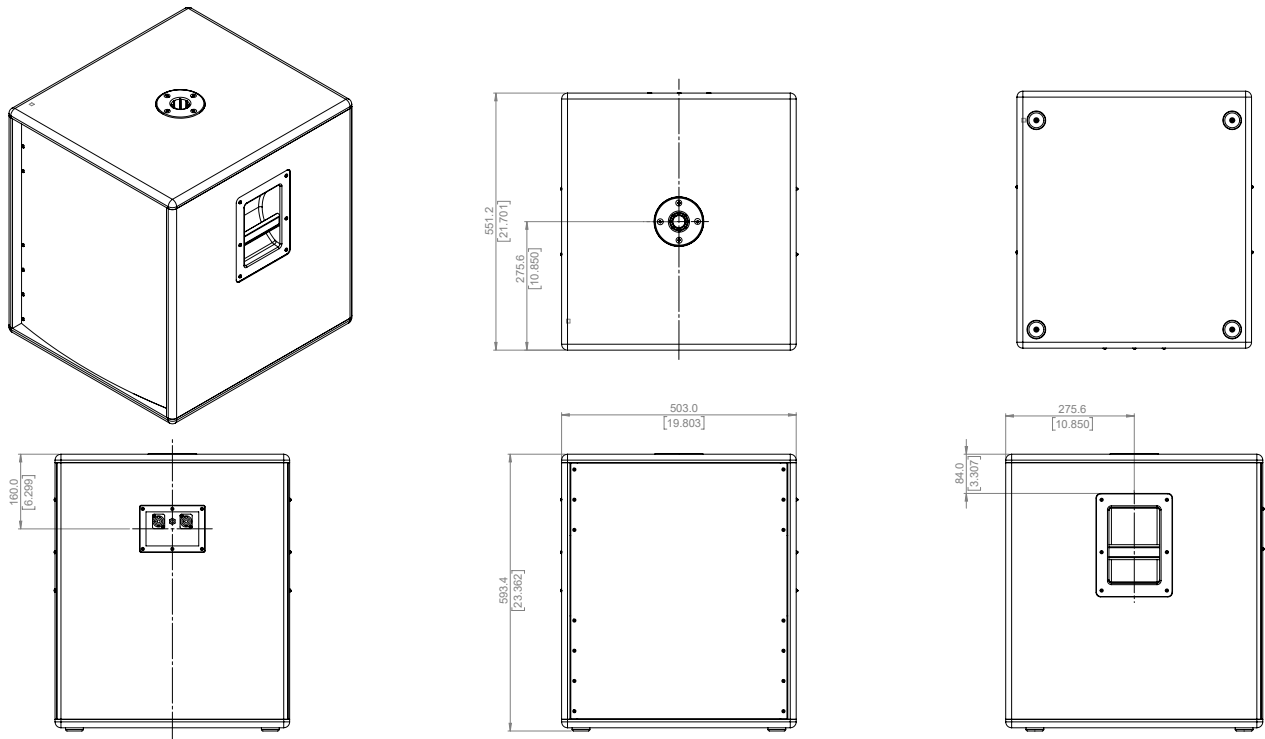

JBL Professional
 8500 Balboa Boulevard, P.O. Box 2200
 Northridge, California 91329 U.S.A.

© Copyright 2018 JBL Professional
 www.jblpro.com

SS PRX318SD

SZ

20/08/18